

Drehstrommotor / Three-Phase Motor

IE3 - 15 kW - 6 polig / 6 pole - B3

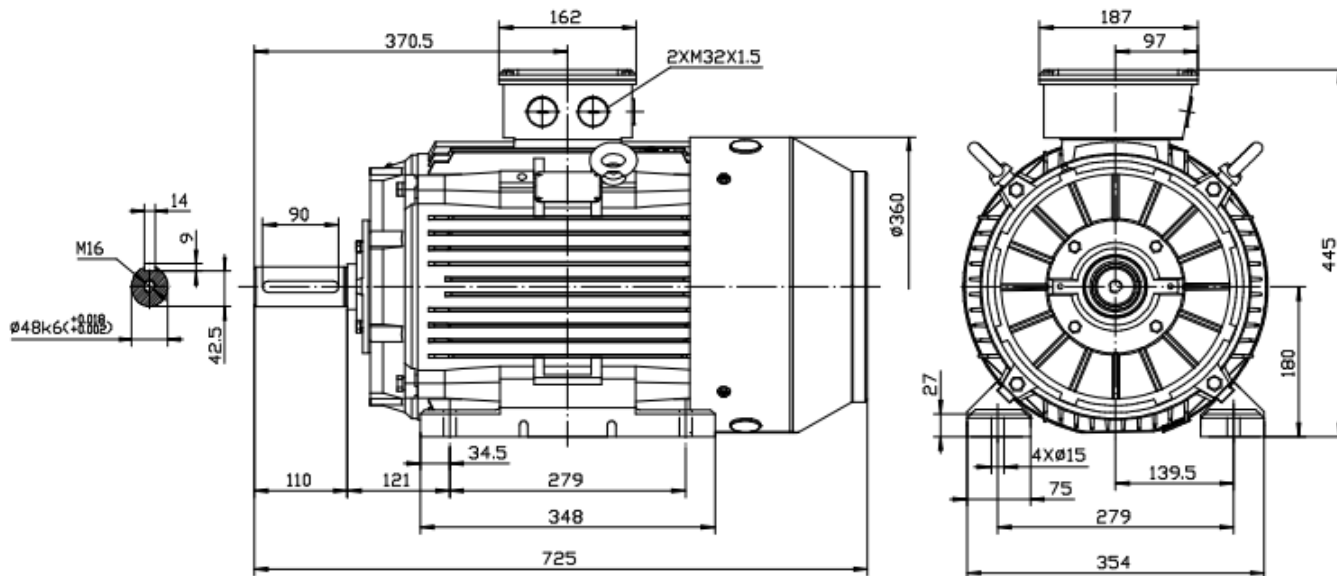

Typ / type

IE3 SEV- 180L-6

Gehäusematerial / frame material		Grauguss / cast iron
Ausführung / execution		Dreiphasen/ three phase
Baugröße / frame size		180
Leistung / power @50Hz	kW	15,00
Nennstrom / rated current @400V	Δ	30,05
Nennstrom / rated current @690V	Y	17,42
Drehzahl / speed @50Hz	Upm / rpm	960
Wirkungsgrad / efficiency	IE3	
	Eff.100%	91,20
	Eff.75%	92,00
	Eff.50%	90,30
Leistungsfaktor / power factor cosφ	Last / load 100%	0,79
60Hz 460/793V	Power(kW)	17,25
60Hz 480/830V	Power(kW)	18,00
Drehzahl / speed @60Hz	(r/min)	1152
Normen / regulations		IEC / DIN / ISO / VDE / EN
Standard / standard		IEC 60034
Umgebungstemperatur / ambient Temp.		-20°C ~ +40°C
Aufstellungshöhe / altitude (max.)		1000m über Meeresspiegel / above sea level

Nenn Drehmoment / rated torque	149,22
Anzugs- zu Nennmoment / start- to rated torque	2,5
Kipp- zu Nennmoment / brakedown- to rated torque	2,8
min. Dreh- zu Nennmoment / min- to rated torque	1,4
Anzugs- zu Nennstrom / starting- to rated current	7,4
Lager / bearing (DE)	6311C3
Lager / bearing (NDE)	6311C3
Wellendichtung / shaft seal (DE/NDE)	55*75*8
Hauptkabelverschraubung / main cable glands	2-M32*1.5
Isolationsklasse / insulation class	F
Schutzart / protection degree	IP 55
Thermischer Schutz / thermal protection	3*PTC
Drehrichtung / rotation direction	rechts-links / clockwise-counterclockwise
Einschaltdauer / service duty	S1
Wuchtung / balance	Halbkeilwuchtung / half-key balanced
Kühlungsart / cooling	IC 411
Lautstärke / noise dB(A)	73
Nettogewicht / net weight(kg)	173,00
Massenträgheitsmoment / moment of inertia (kg*m ²)	0,279730000