

Drehstrommotor / Three-Phase Motor

IE4 - 160 kW - 4 polig / 4 pole - B35

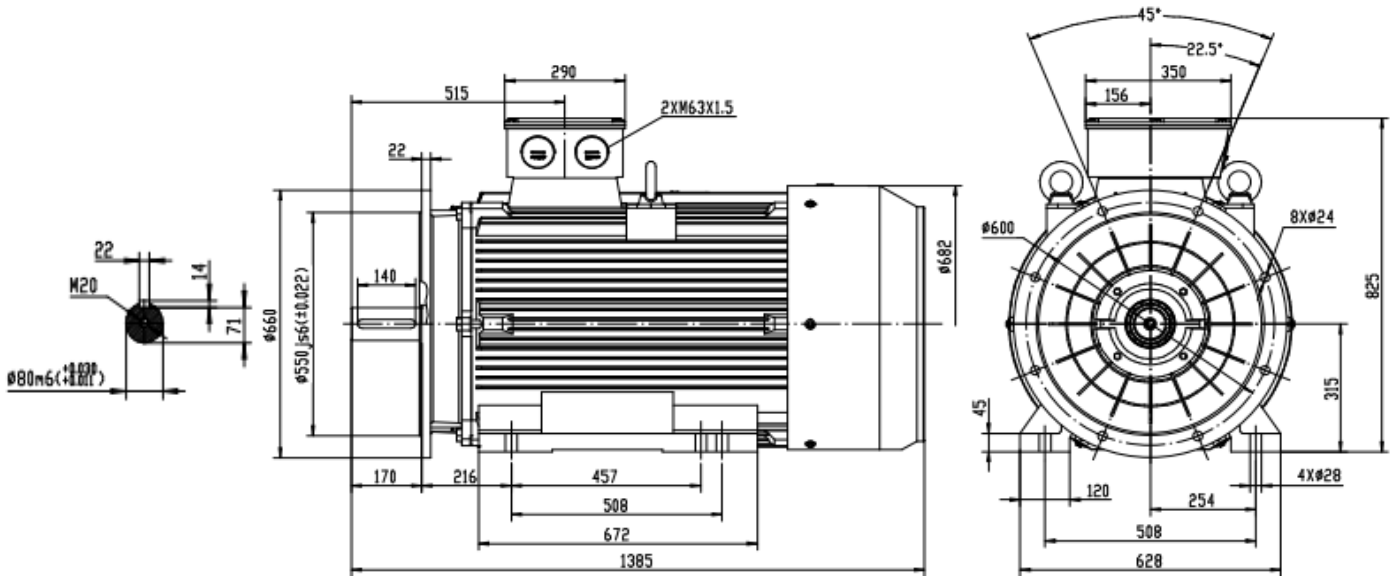

Typ / type

IE4 SEV- 315L1-4

Gehäusematerial / frame material		Grauguss / cast iron
Ausführung / execution		Dreiphasen/ three phase
Baugröße / frame size		315
Leistung / power @50Hz	kW	160,00
Nennstrom / rated current @400V	Δ	265,63
Nennstrom / rated current @690V	Y	153,99
Drehzahl / speed @50Hz	Upm / rpm	1485
Wirkungsgrad / efficiency	IE4	
	Eff. 100%	96,60
	Eff. 75%	96,60
	Eff. 50%	96,30
Leistungsfaktor / power factor cosφ	Last / load 100%	0,90
60Hz 460/793V	Power(kW)	184,00
60Hz 480/830V	Power(kW)	192,00
Drehzahl / speed @60Hz	(r/min)	1782
Normen / regulations		IEC / DIN / ISO / VDE / EN
Standard / standard		IEC 60034
Umgebungstemperatur / ambient Temp.		-20°C ~ +40°C
Aufstellungshöhe / altitude (max.)		1000m über Meeresspiegel / above sea level

Nenn Drehmoment / rated torque	1029,40
Anzugs- zu Nennmoment / start- to rated torque	1,8
Kipp- zu Nennmoment / brakedown- to rated torque	2,2
min. Dreh- zu Nennmoment / min- to rated torque	1
Anzugs- zu Nennstrom / starting- to rated current	8,5
Lager / bearing (DE)	NU319
Lager / bearing (NDE)	6317C3
Wellendichtung / shaft seal (DE/NDE)	95*120*12
Hauptkabelverschraubung / main cable glands	2-M63*1.5
Isolationsklasse / insulation class	F
Schutzart / protection degree	IP 55
Thermischer Schutz / thermal protection	3*PTC
Drehrichtung / rotation direction	rechts-links / clockwise-counterclockwise
Einschaltdauer / service duty	S1
Wuchtung / balance	Halbkeilwuchtung / half-key balanced
Kühlungsart / cooling	IC 411
Lautstärke / noise dB(A)	88
Nettogewicht / net weight(kg)	1113,00
Massenträgheitsmoment / moment of inertia (kg*m ²)	5,267381570